

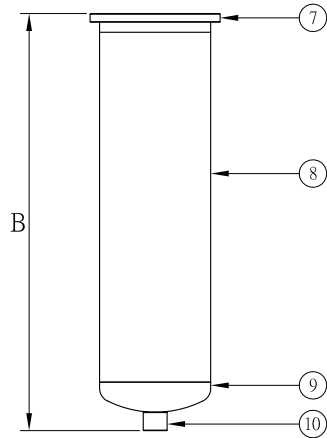

TSH SERIES >>>

高圧型対応1本入りカートリッジハウジング

High Pressure Single Cartridge Filter Housing

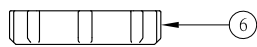
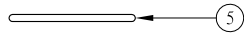
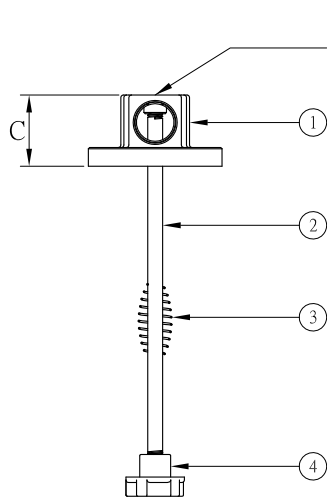
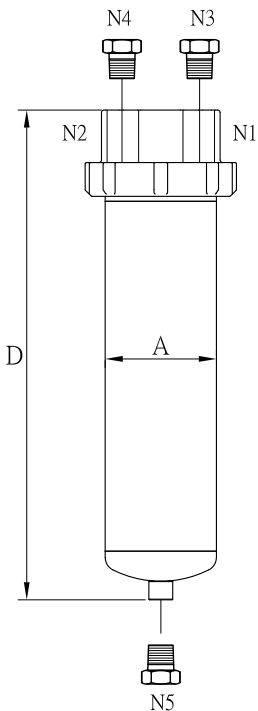
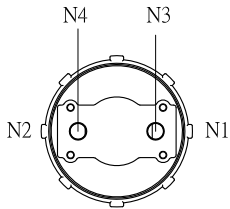
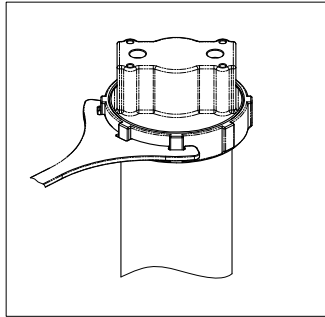

N3 1/4"PT-F
N4 1/4"PT-F

N5 1/4"PT-F

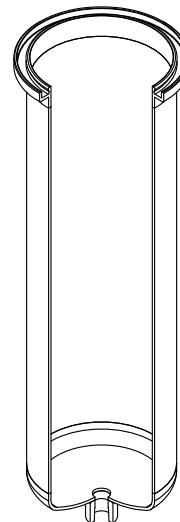
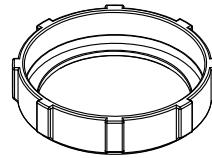
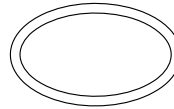
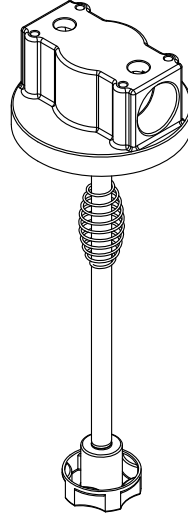

- ... 設計圧力 Design P. ... 30kg/cm²
- ... 操作圧力 Operating P. ... 21kg/cm²
- ... 設計温度 Design T. ... 100°C
- ... 操作温度 Operating T. ... 75°C

NO.	部品名 Description
1	カートリッジ受座 Cartridge support plate
2	ボルト Screw rod
3	スプリング Springs
4	ナット Nut
5	O-リング O-ring
6	リングナット Round nut
7	シェルフランジ Shell flange
8	シェル Shell
9	ボトム Bottom cover
10	ドレン Drain

形式 Model	Length of Cartridge	A m/m	B m/m	C m/m	D m/m	M ³ /Hr	GPM	重量 Weight
TSH1	10"	φ88.9	334	57	391	1	5	5.5kg
TSH2	20"	φ88.9	584	57	641	2	10	6.5kg
TSH3	30"	φ88.9	834	57	891	3	15	7.5kg

* フィルターエレメントはオプション品です。
* Filter element for optional purchase.