



# 1RS SERIES >>>

1本入りサニタリカートリッジハウジング

## Sanitary Single Cartridge Filter Housing

- ... 設計圧力 Design P. ... 10kg/cm<sup>2</sup>
- ... 操作圧力 Operating P. ... 7kg/cm<sup>2</sup>
- ... 設計温度 Design T. ... 100°C
- ... 操作温度 Operating T. ... 75°C

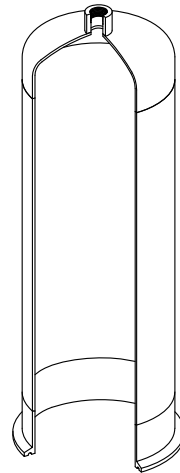
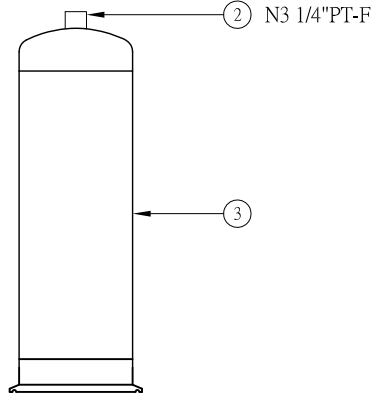
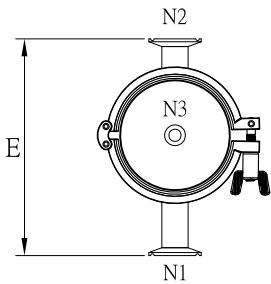
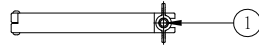
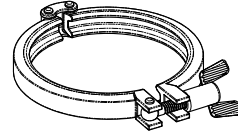

NO.	部品名 Description
1	クランプ Clamp
2	ベント Vent
3	シェル Shell
4	ガスケット Gasket
5	カートリッジ Filter cartridge
6	ベース Base
7	入口 Port inlet
8	出口 Port outlet
9	脚 Support leg

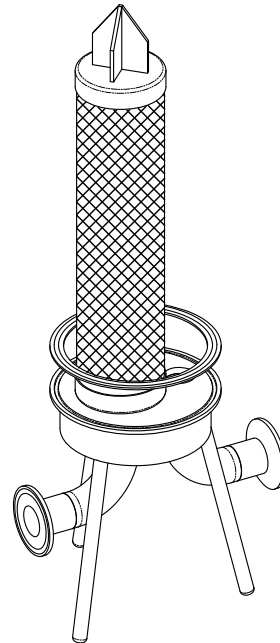
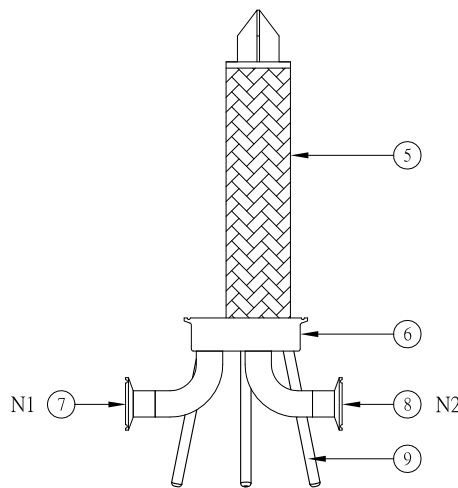
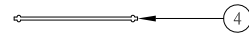
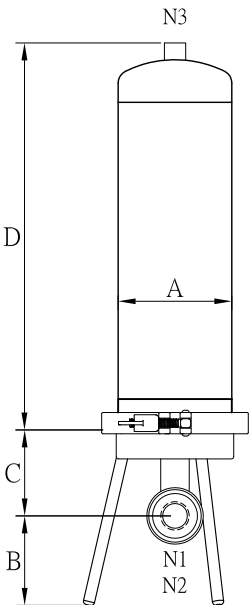

型式 Model	Length Of Cartridge	A m/m	B m/m	C m/m	D m/m	E m/m	M <sup>3</sup> /Hr	GPM	重量 Weight
1RS 1	10"	φ101.6	77	83	340	207	1	5	4.5kg
1RS 2	20"	φ101.6	77	83	590	207	2	10	6.0kg
1RS 3	30"	φ101.6	77	83	840	207	3	15	7.5kg

\*上記寸法はN1を1" Sに適用する。それ以外の口径を求める場合はコネクターで接続する必要がある。

\*SYS standard inlet/outlet size is 1", other size needs to use transfer adaptor.

\* フィルターエレメントはオプション品です。

\* Filter element for optional purchase.