

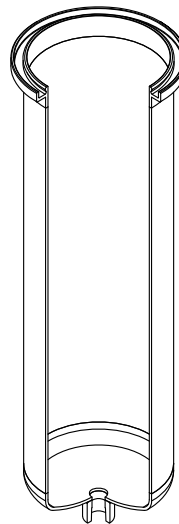

TSH SERIES >>> 高壓單支裝濾芯機

High Pressure Single Cartridge Filter Housing

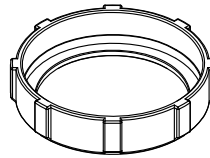
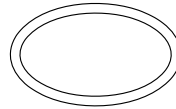
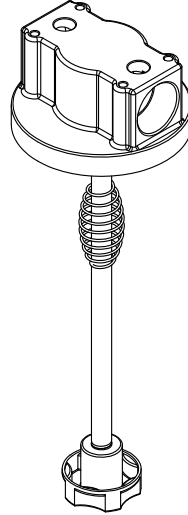
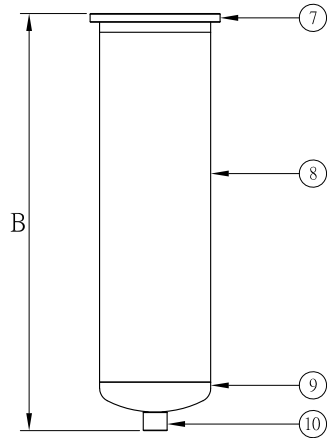
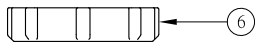
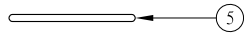
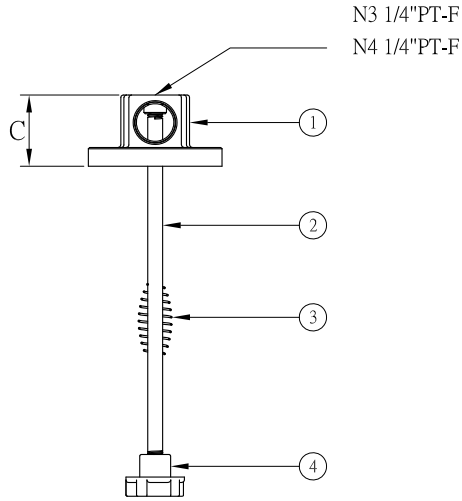
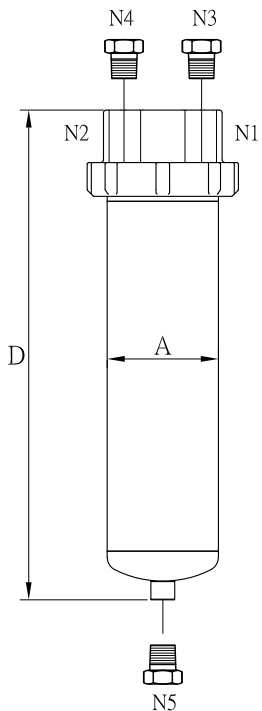
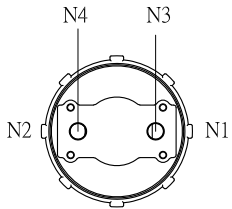
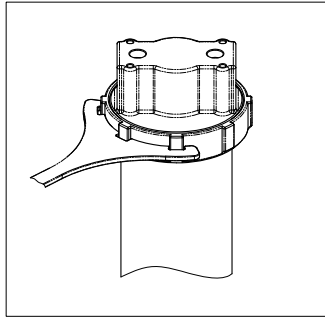

... 設計壓力 Design P.	... 30kg/cm ²
... 操作壓力 Operating P.	... 21kg/cm ²
... 設計溫度 Design T.	... 100°C
... 操作溫度 Operating T.	... 75°C

NO.	名稱 Description
1	集水座 Cartridge support plate
2	濾芯螺桿 Screw rod
3	彈簧 Springs
4	濾芯鎖螺 Nut
5	O 型環 O-ring
6	集水頭螺母 Round nut
7	桶唇 Shell flange
8	桶體 Shell
9	端板 Bottom cover
10	排放口 Drain

型式 Model	Length of Cartridge	A m/m	B m/m	C m/m	D m/m	M ³ /Hr	GPM	重量 Weight
TSH1	10"	∅88.9	334	57	391	1	5	5.5kg
TSH2	20"	∅88.9	584	57	641	2	10	6.5kg
TSH3	30"	∅88.9	834	57	891	3	15	7.5kg

* 濾芯僅供選購

* Filter element for optional purchase.